

MATERIALES CURRICULARES

Lengua Árabe اللغة العربية
Educación Infantil: 5 años التعليم الأولي: خمس سنوات

- La Primavera y los Animales فصل الربيع والحيوانات
- El Cuerpo, La Salud y la Alimentación الجسم، الصحة والتغذية
- El Verano فصل الصيف

كتاب التلميذ

Libro del alumno

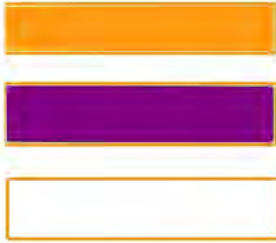



**MINISTERIO DE EDUCACIÓN, CULTURA
Y DEPORTE**

Subsecretaría

Subdirección General de Cooperación Internacional

Título: MATERIALES CURRICULARES DE LENGUA ÁRABE. EDUCACIÓN INFANTIL. 5
AÑOS.

La primavera y los animales. El cuerpo, la salud y la alimentación. El verano.

Autores: Hassan el Harchal
Loubna Toumsy
Fátima Tawgui
Naima Zeroual
Rafael Monclova Fernández

Coordinación de la publicación: Rafael Monclova Fernández

Consejero de Educación: Miguel Zurita Becerril

Edita:

© SECRETARÍA GENERAL TÉCNICA

Subdirección General de Documentación y Publicaciones

Edición: 2012

NIPO papel: 030-12-427-6

NIPO línea: 030-12-435-7

ISBN: 978-9954-39-029-0

Depósito legal: 2012MO3314

Embajada de España en Marruecos

Consejería de Educación

9, Av. Marrakech. 10.000 Rabat (Marruecos)

Tel.: ~~+212 (0) 537767558 / 59~~ – Fax: ~~+212 (0) 537767557~~

<http://www.educacion.es/exterior/ma/es/>

e-mail: consejeria.ma@educacion.es

Diseño y maqueta: Rafael Monclova Fernández

Imprime: Scriptura - Rabat



Lengua Árabe. Educación Infantil. 5 años اللغة العربية. التعليم الأولي. خمس سنوات.

Unidades Didácticas.

الوحدات الـديداكتيكية

- La Primavera y los Animales
• فصل الربيع والحيوانات
- El Cuerpo, la Salud y la Alimentación
• الجسم، الصحة والتغذية
- El Verano
• فصل الصيف

كتاب التلميذ

Libro del alumno

Hassan El Harchal
Fatima Tawgui
Loubna Toumsy
Naima Zeroual
Rafael Monclova Fernández (coordinador)

Ilustraciones : Abderrafie El Ghayyat



فصل الربيع والحيوانات

LA PRIMAVERA Y LOS ANIMALES

التعليم الأولي EDUCACIÓN INFANTIL

المستوى: 5 سنوات NIVEL: 5 AÑOS

مريم في مزرعة جدتها



1



2



3

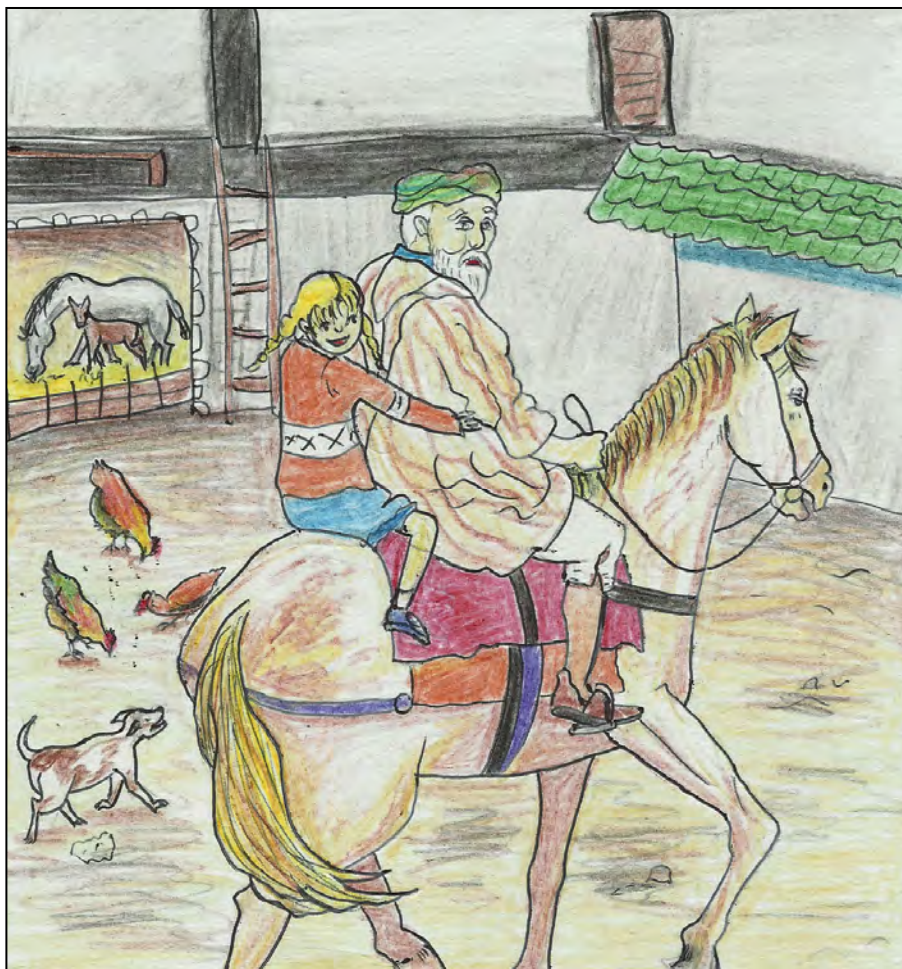

4

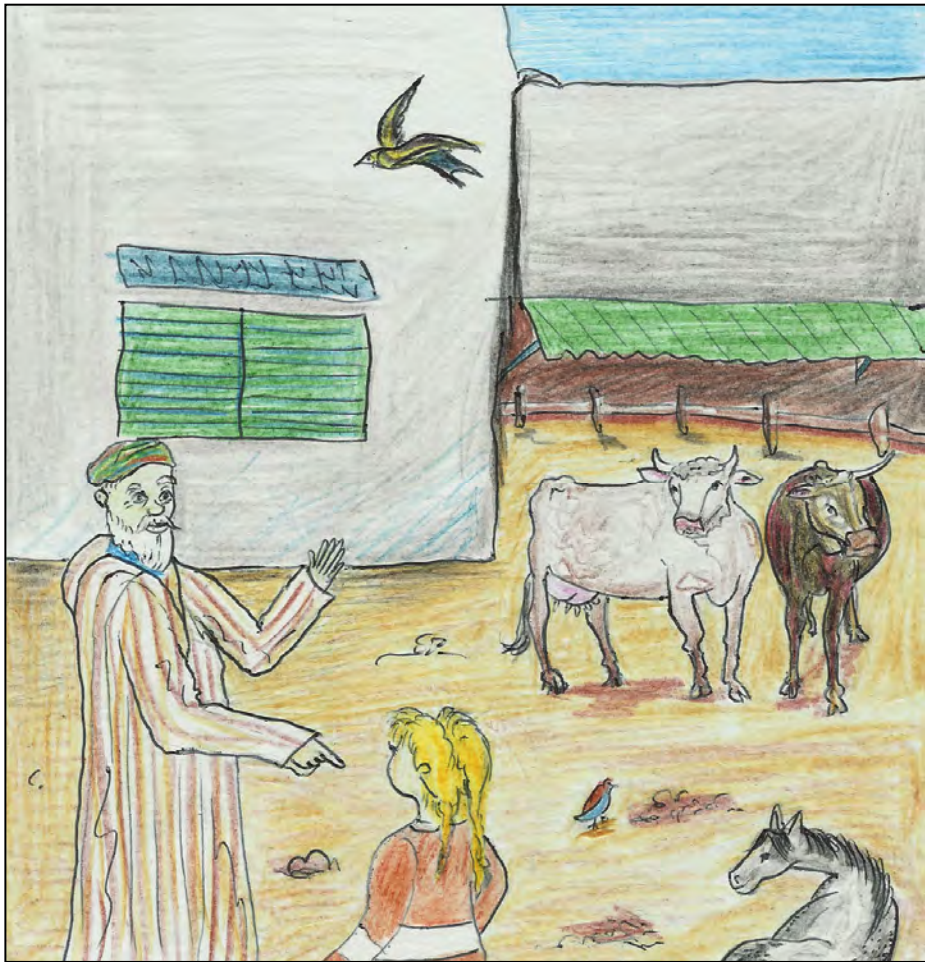

5



6

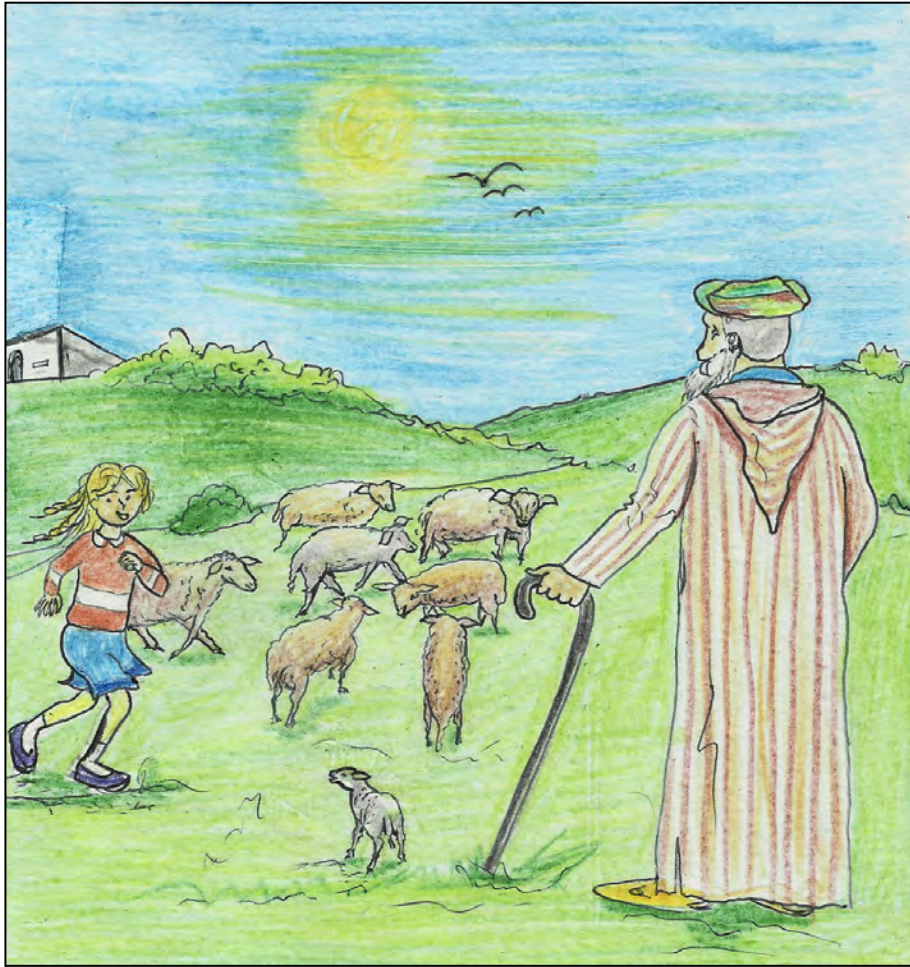

7

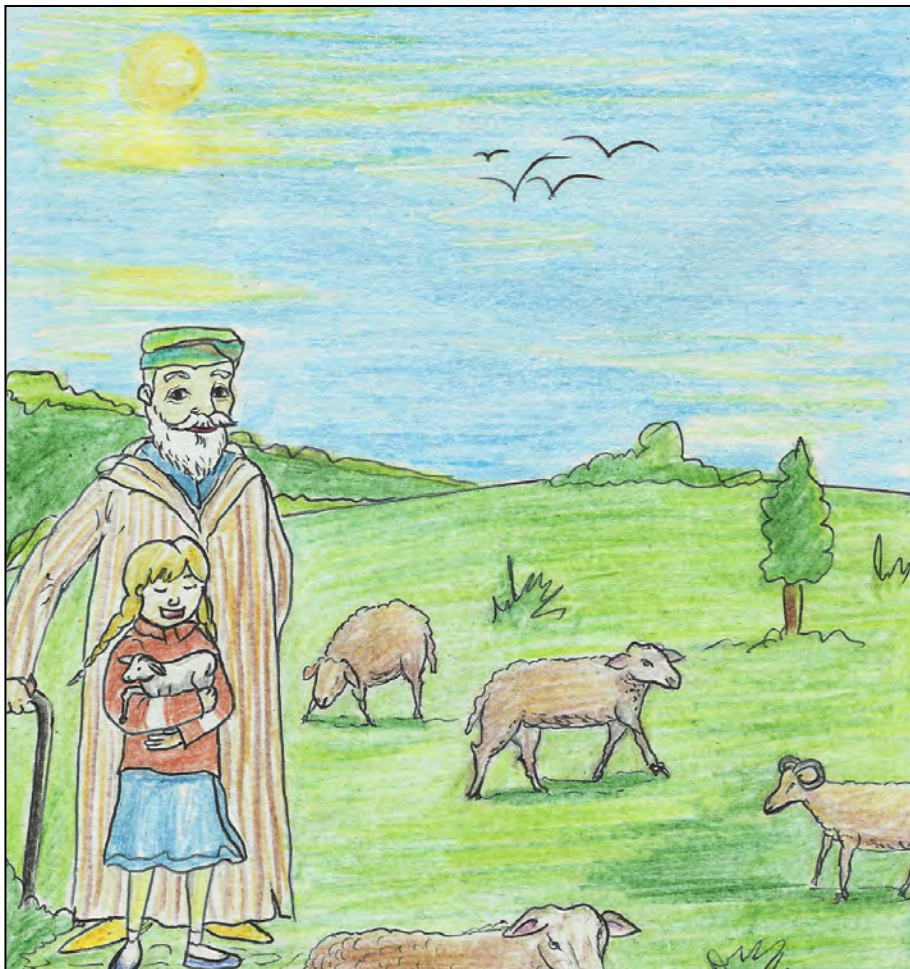

8



حيوانات المزرعة



بقرة



ثور



دجاج



خرفان

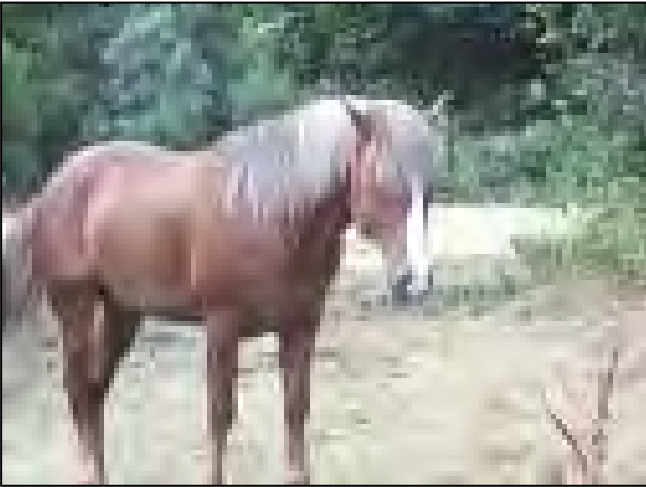

حصان



بط

حيوانات المزرعة



خروف صغير



أرانب



عشب أخضر



أزهار

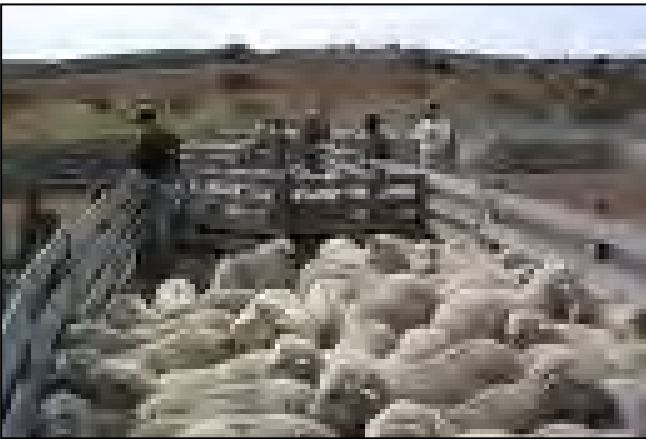

زربية



إسطبل

حيوانات الغابة



نمر



أسد



زرافة



فيل



غزال



دب

نظيف - قذر



ألون حيوانات المزرعة

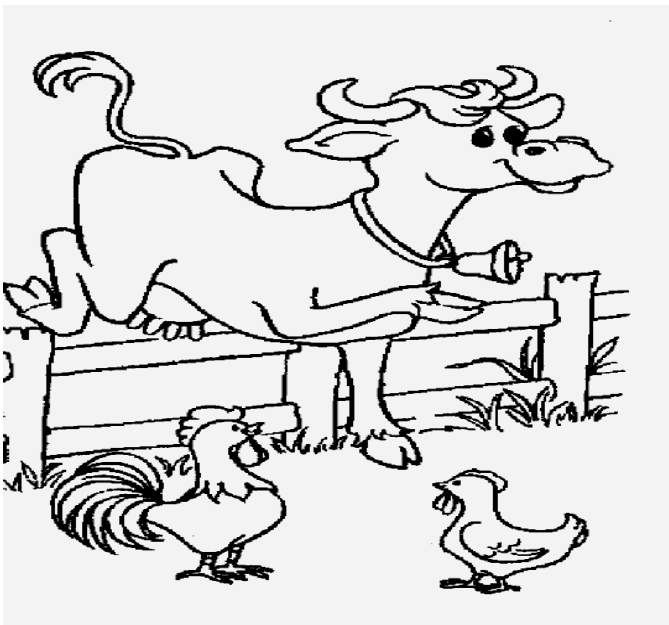
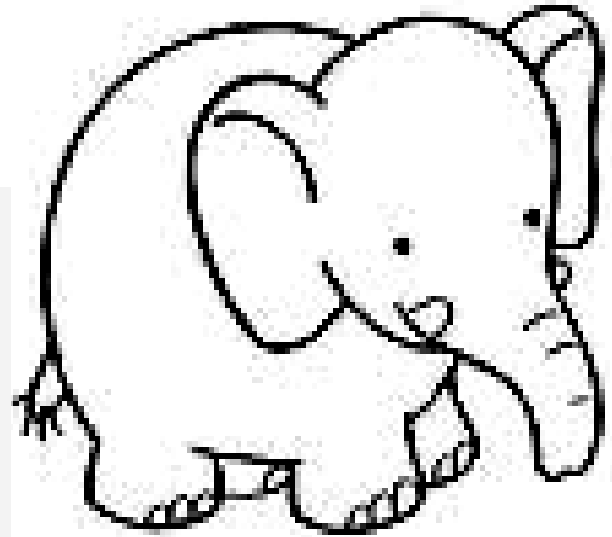
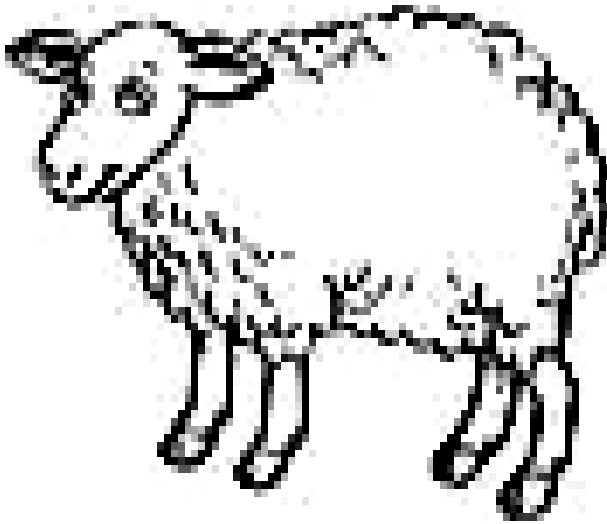
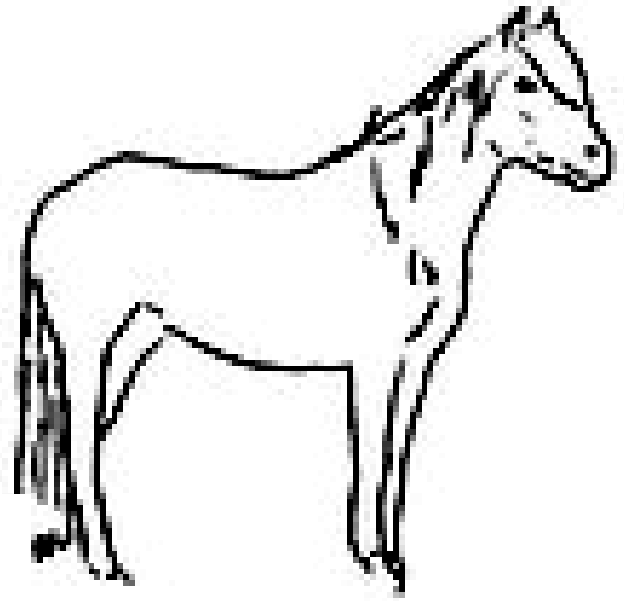

ر ر

حرف الراء :

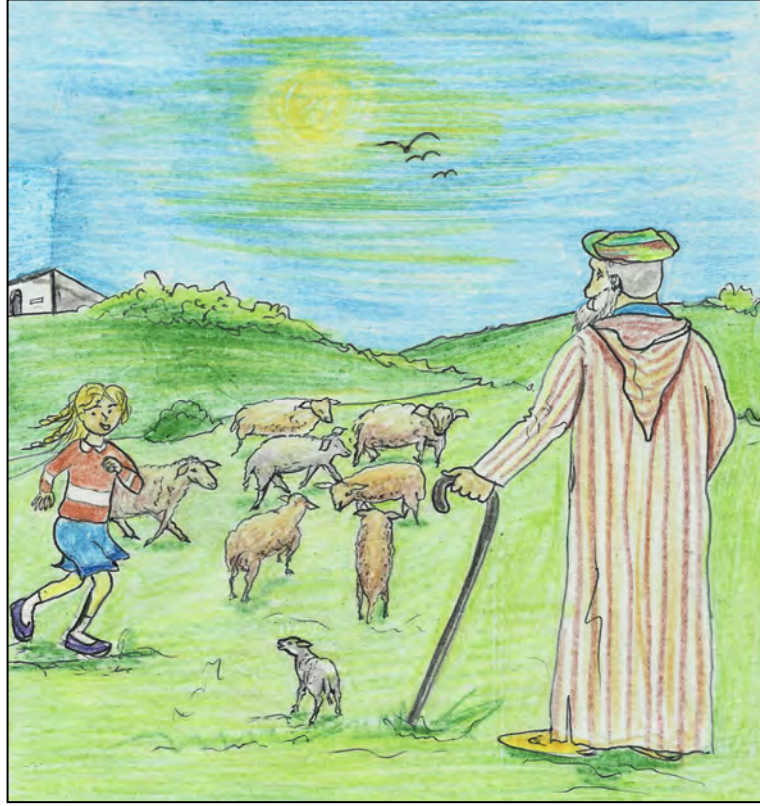

مريم تجري وراء الخروف الصغير.



ألون حرف الراء:

ثور

دب

زرافة

نشيد: فصل الربيع

أهلاً بفصل الأزهار
والورد والأقحوان

والطير يشدو الألحان
والفرشات على الأغصان





الجسم، الصحة والتغذية

EL CUERPO, LA SALUD Y LA ALIMENTACIÓN

التعليم الأولي EDUCACIÓN INFANTIL

المستوى: 5 سنوات NIVEL: 5 AÑOS

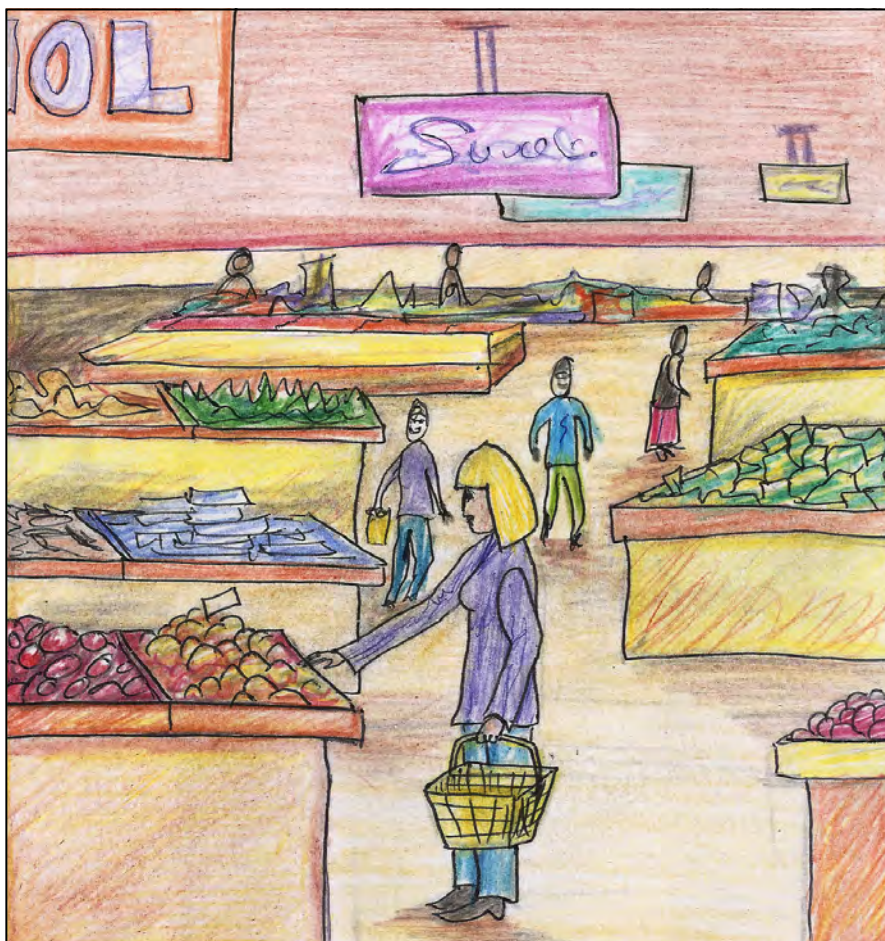

1

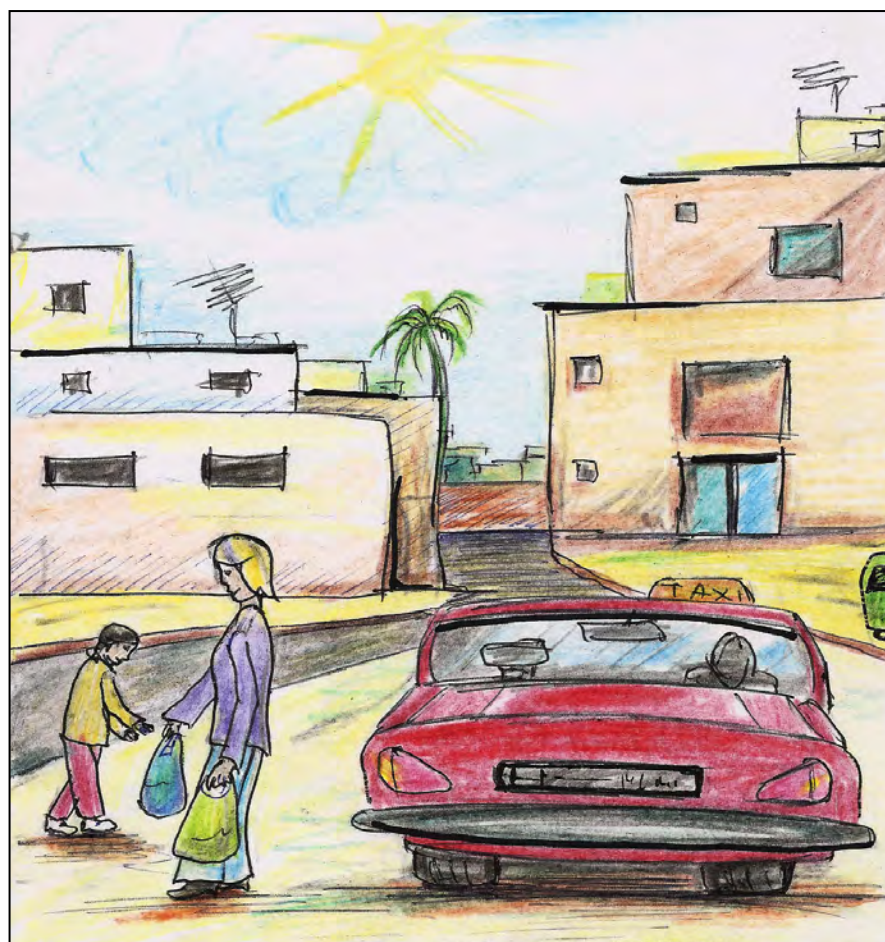

2



3

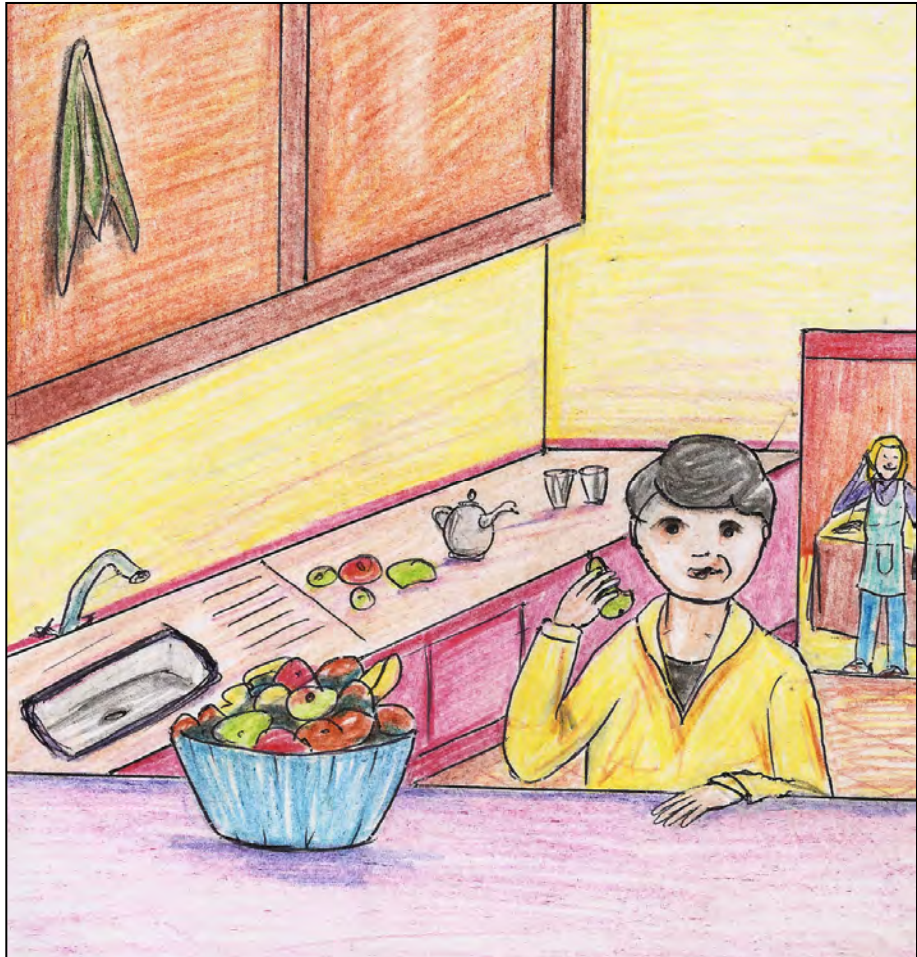

4

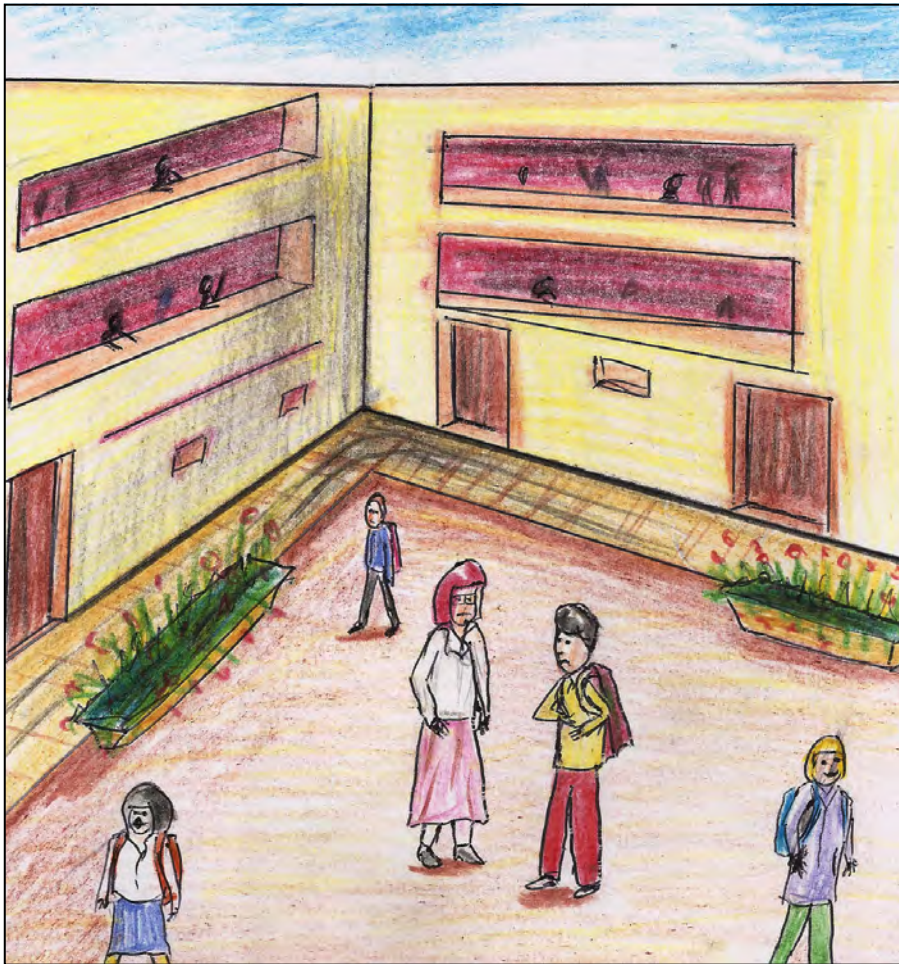

5



6



7



8





فواكه



خضر

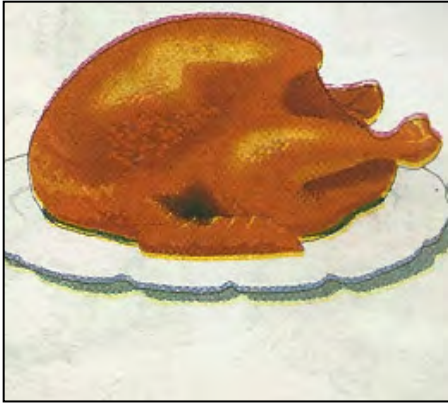

دجاج

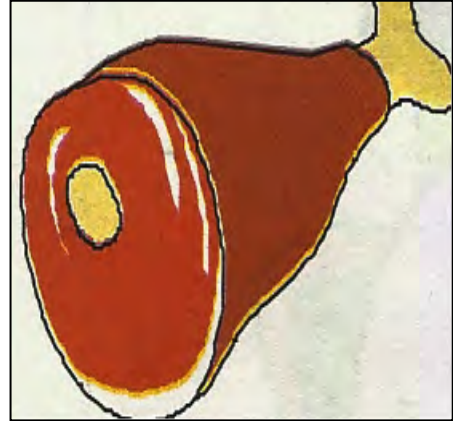

لحم



زبدة

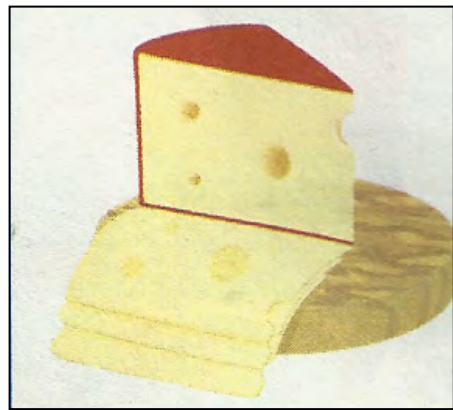

جبين

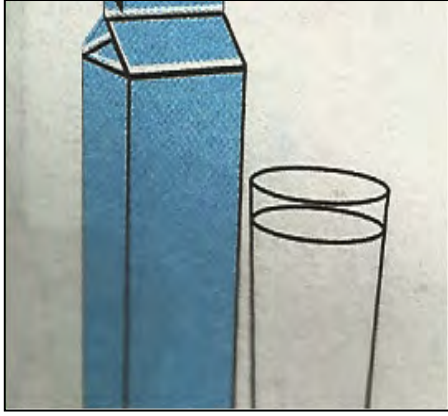

حليب

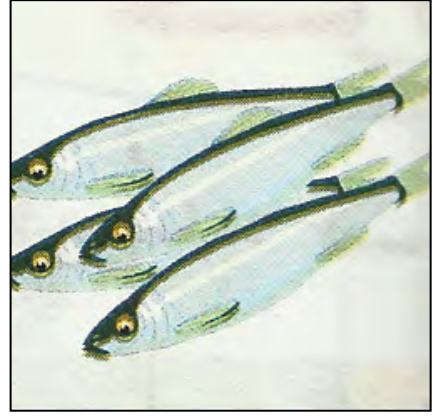

سمك



عسل



بيض



ماء



عصير

نظافة الجسم



صابونة

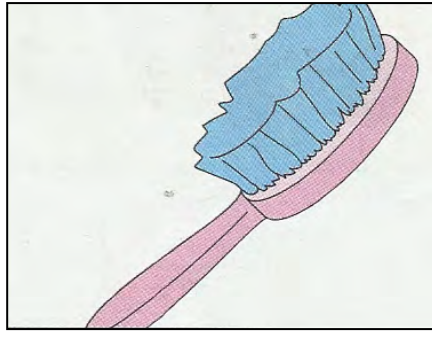

مشط



حمام

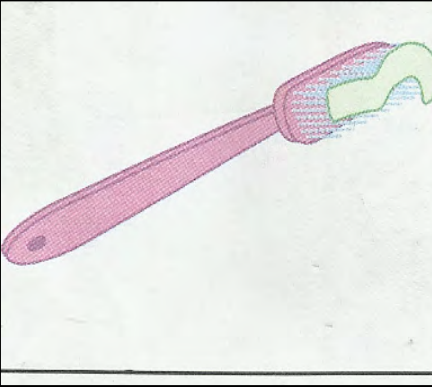

فرشاة



معجون الأسنان



فوطه



كيس الإغتسال

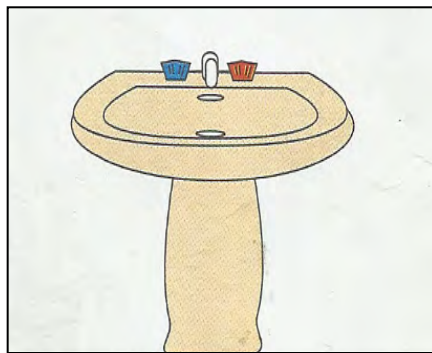

حنفية

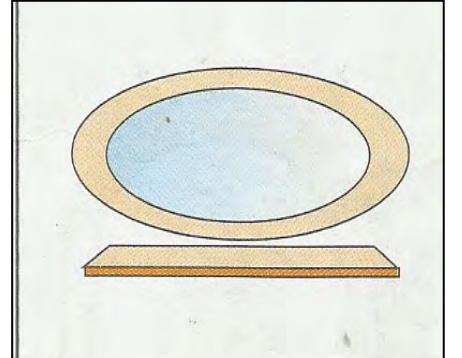

مرآة

الصحة



صيدلية

دواء



في المصحة



طبيب



ممرضة

اعضاء الجسم:



شفتان



أنف



أذن

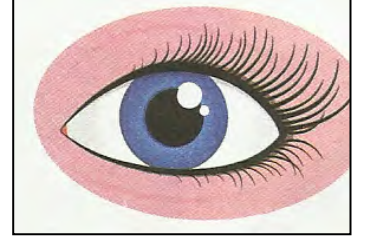

عين



أسنان



فم



شعر



رأس

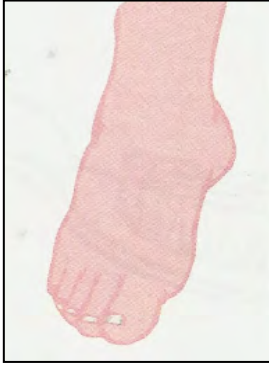

قدم

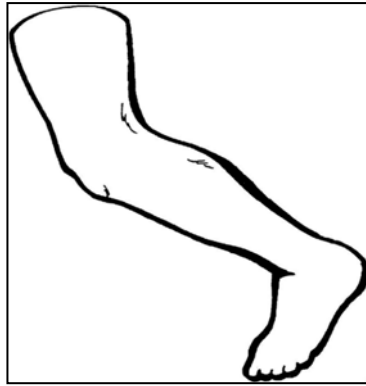

رجل



يد

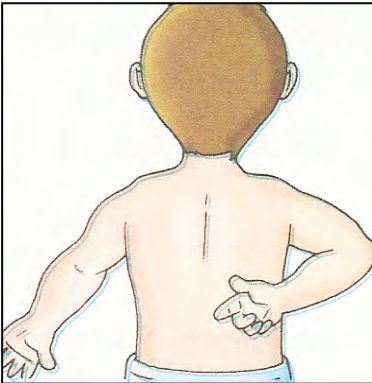

ظهر



بطن



أصابع

المفاهيم: نحيف، غليظ أو سمين:



شمعة غليظة

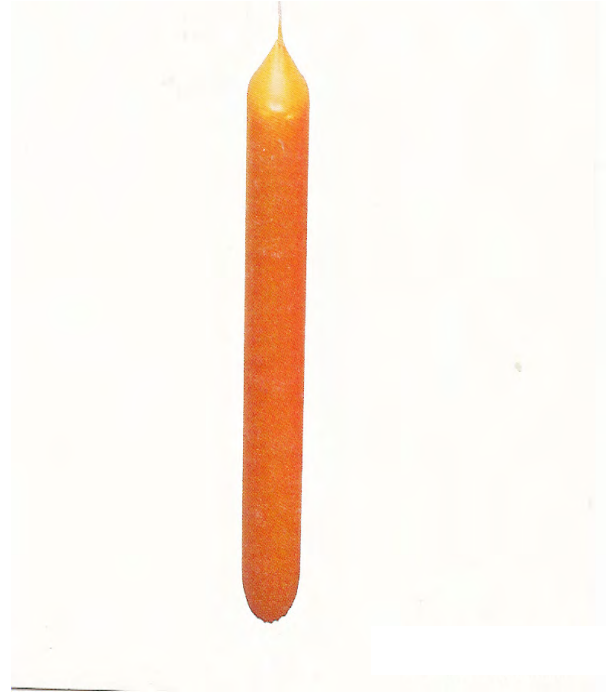

شمعة نحيفة



ولد نحيف



بنت سمينة

ألون صور الخضر والفواكه:

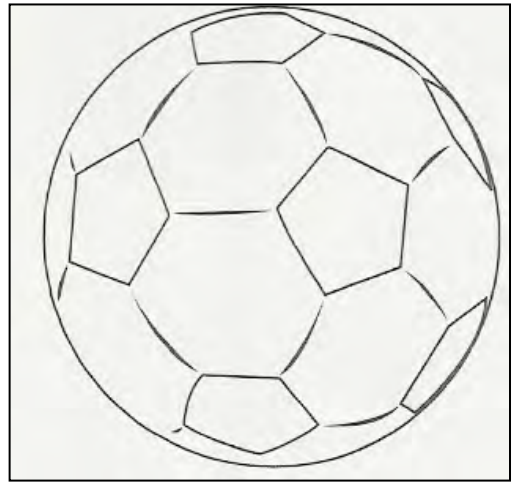
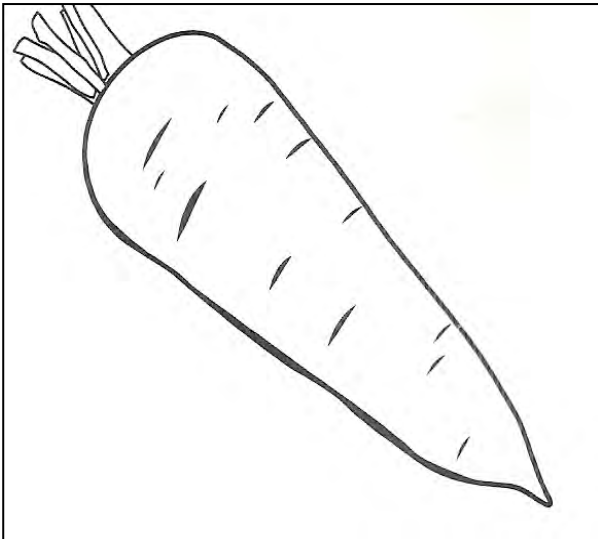
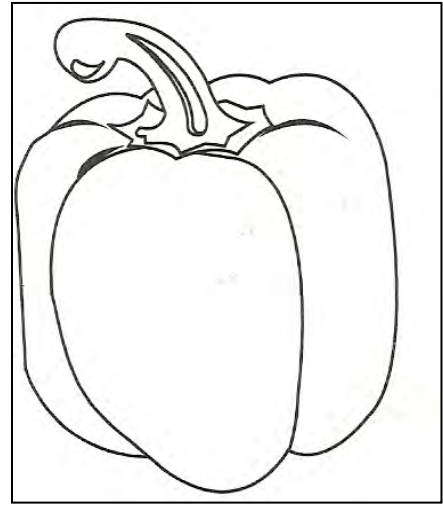
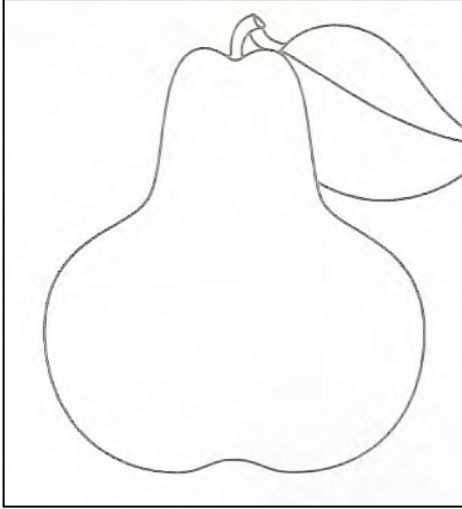
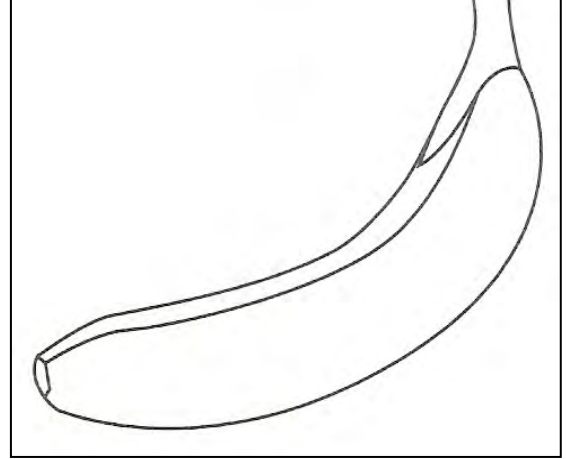

ألف

حرف الألف:



قال كمال : أكلت إجاصة لذيذة.

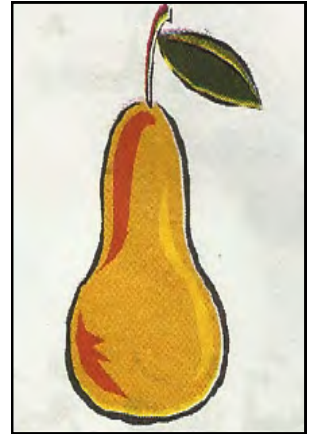
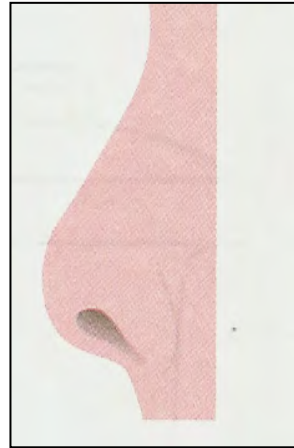

ألون حرف الألف

ماء

رأس

أنف

إجاصة

نشيد: أحافظ على أسناني



دوماً أحفظها

بالسنون أنظفها



فصل الصيف

EL VERANO

التعليم الأولي EDUCACIÓN INFANTIL

المستوى: 5 سنوات NIVEL: 5 AÑOS

مريم وأسرتها في شاطئ البحر



1

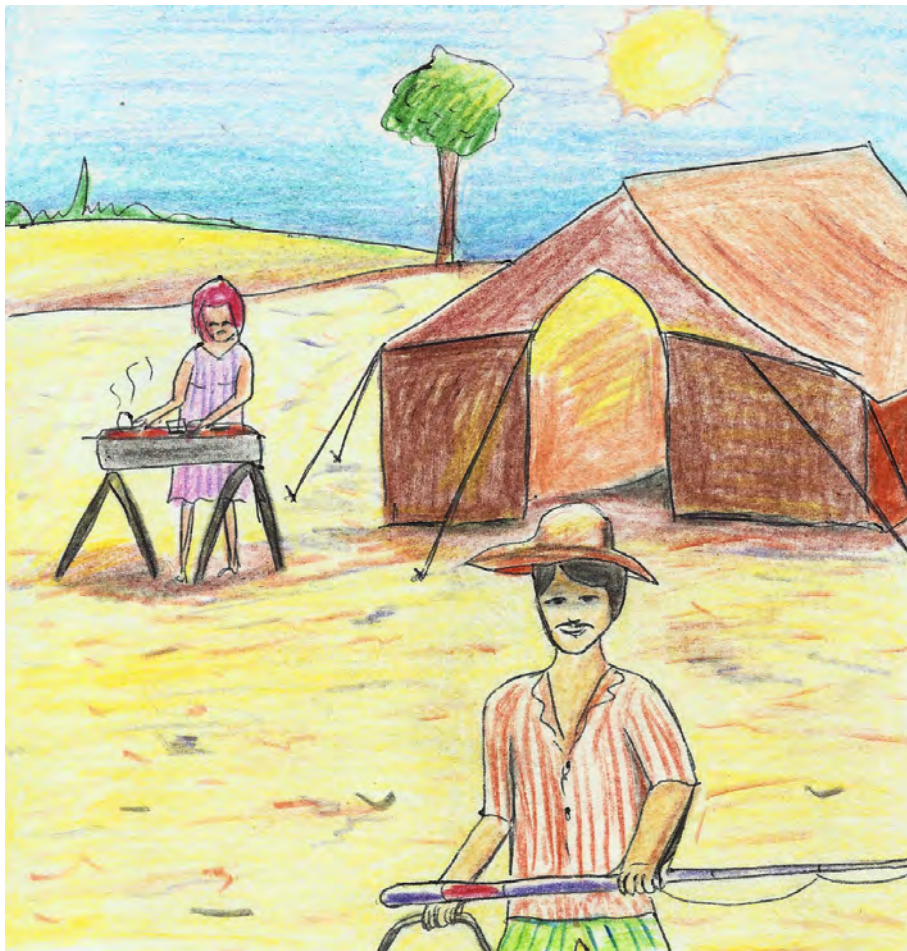

2



3

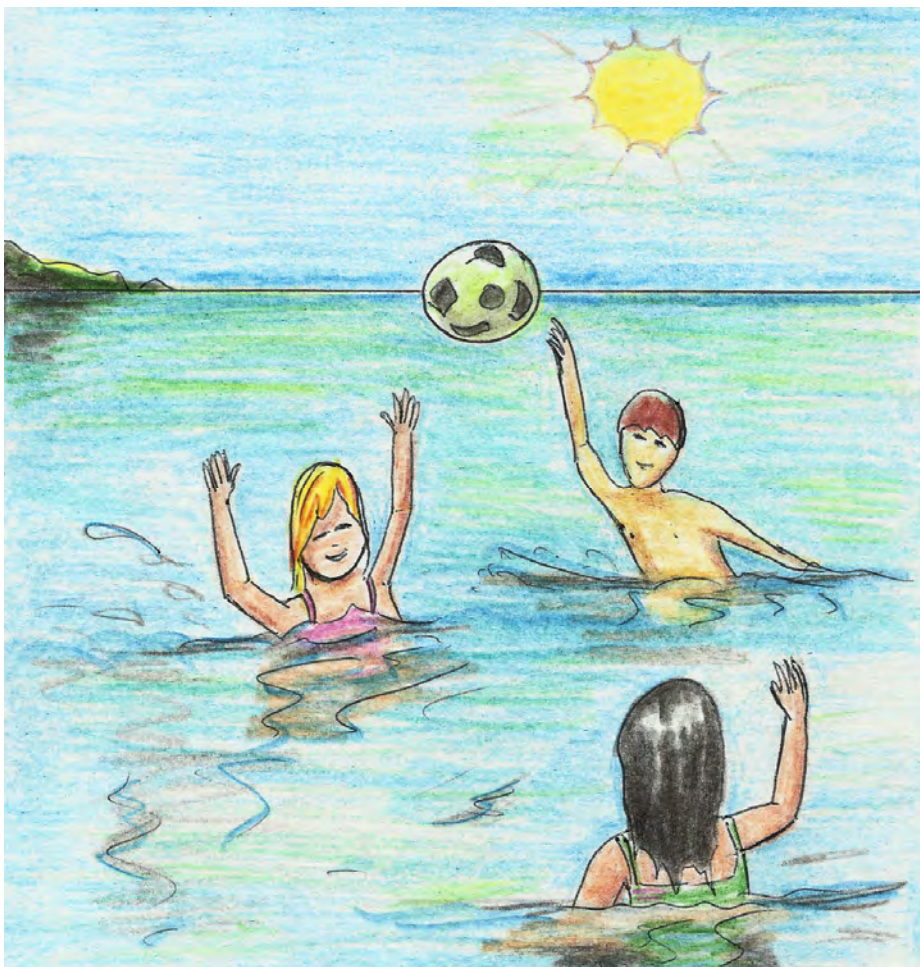

4



5

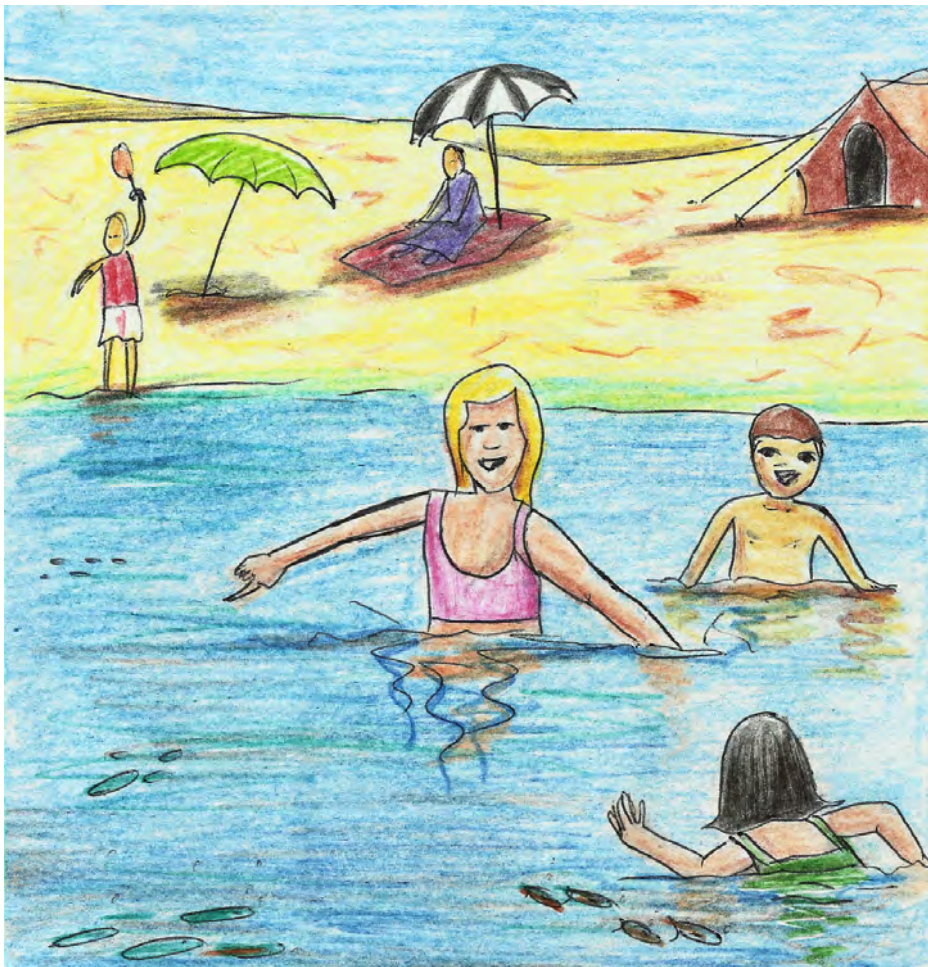

6

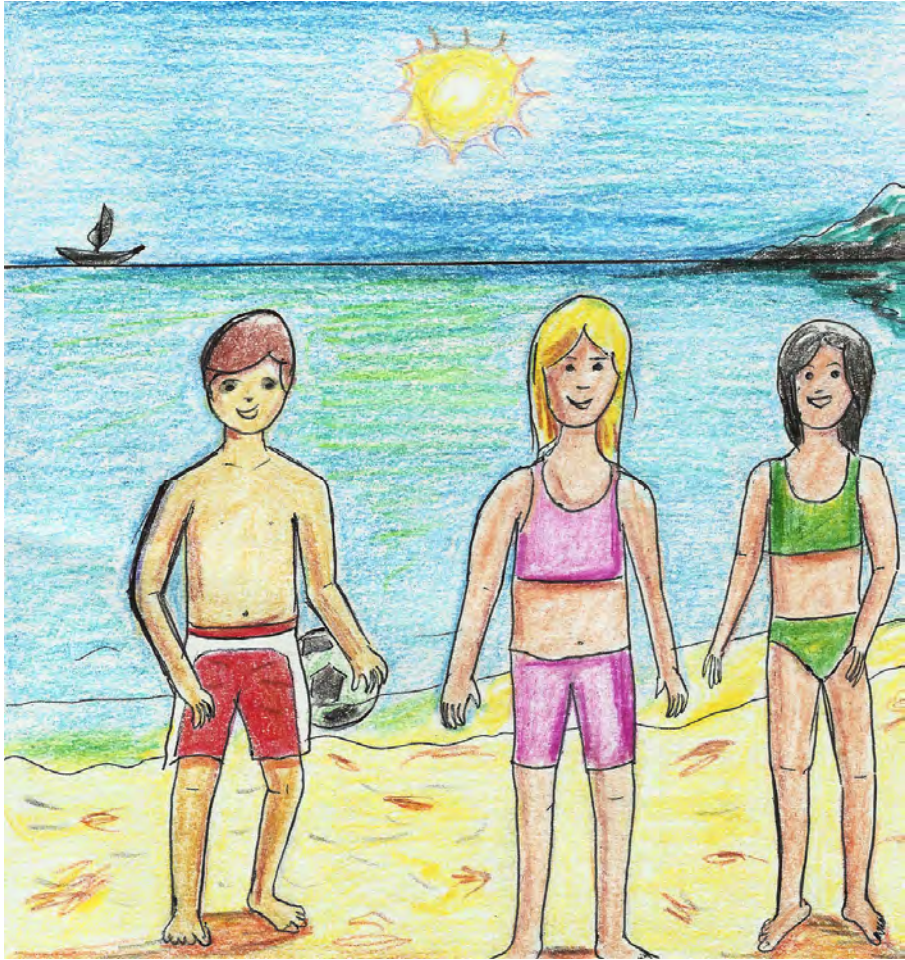

7



8



9



10



لعب

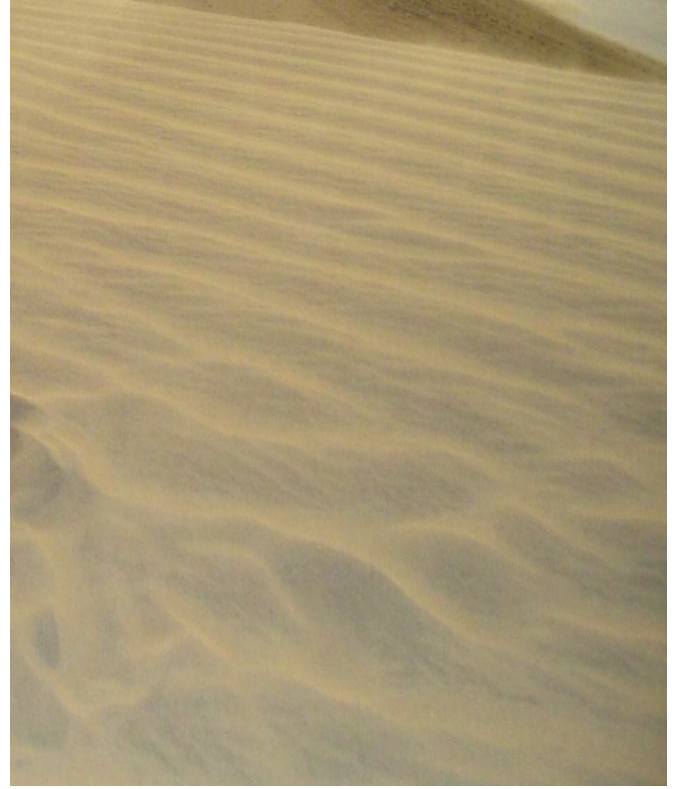

رمال



شاطئ



مسبح

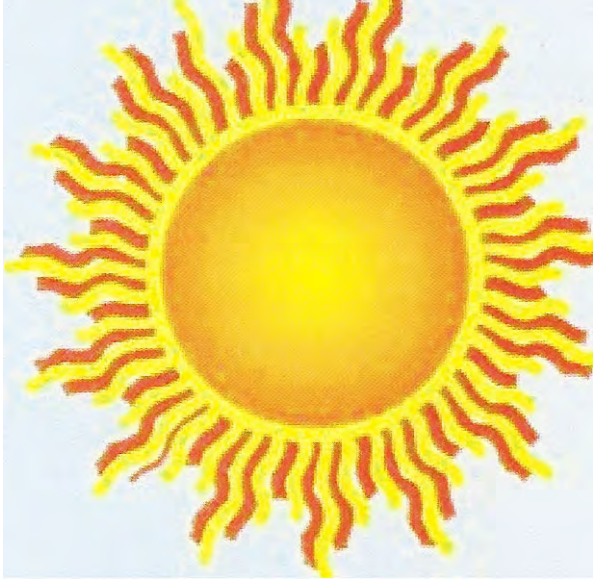

شمس

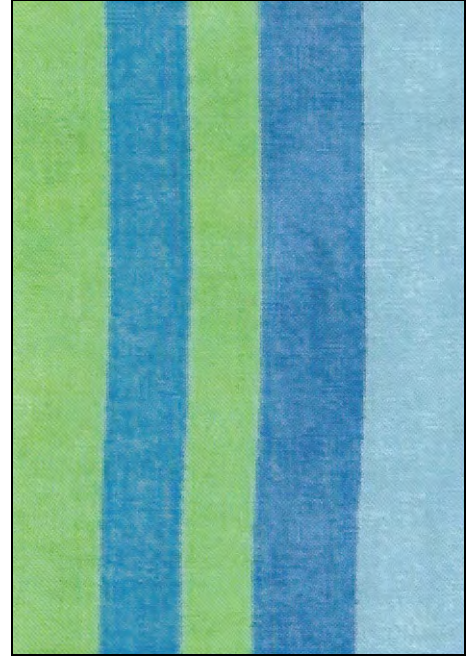

فوطه



كرسي شاطئي



مظلة



أسماك

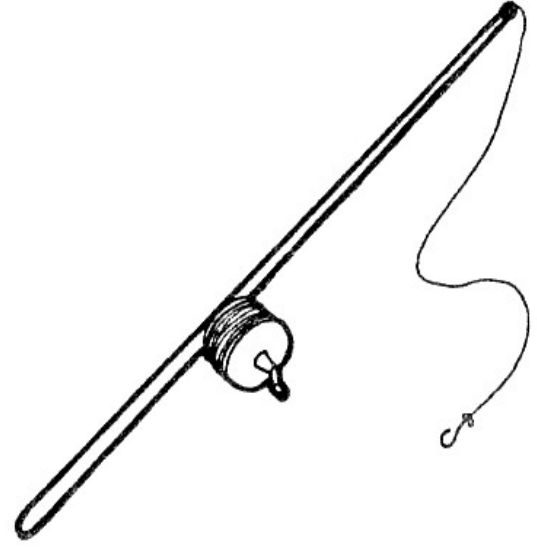

قصة صيد



مركب شراعي



خيمة

تقديم مفهومي : بارد، ساخن

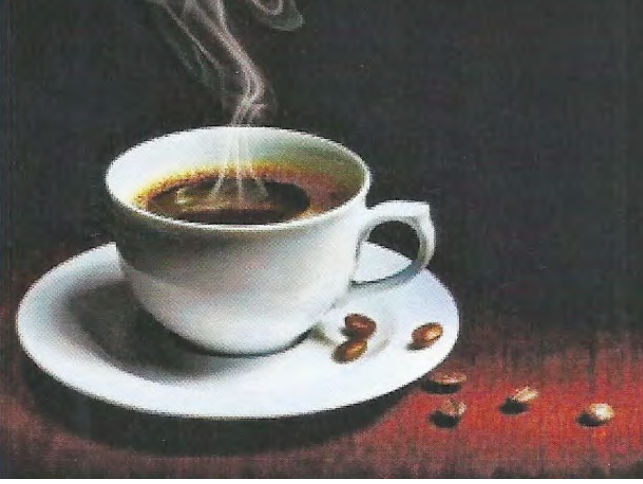

قهوة ساخنة

ثلجة باردة



ألون ما نحتاجه بالشاطيء:

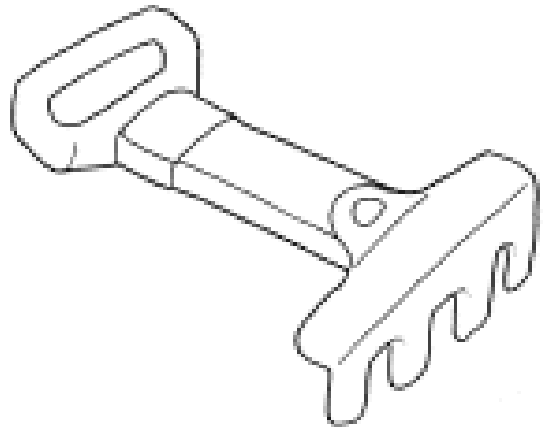
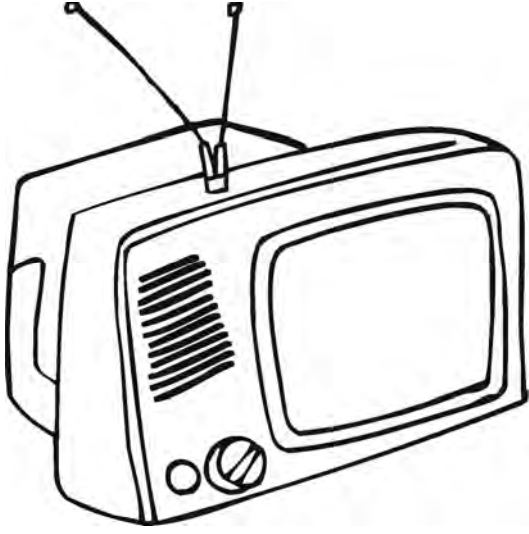

ب ب ب

حرف الباء:



ذهبت مريم مع أمها وأبيها إلى الشاطي



ألون حرف الباء

لعب

مسبح

بطة

نشيد: فصل الصيف

مرحبا بفصل الأسفار °°° هيا هبوا يا صغار

لقاؤنا فوق الرمال °°° أو في الغاب والجبال

مرحبا بفصل الأسفار °°° هيا هبوا يا صغار

فالصيف فصل الأسفار °°° هيا استعدوا يا صغار



CONSEJERÍA DE EDUCACIÓN